

WALL MOUNTS

EP + Sylomer®: Models and dimensions

LOAD AMC DEL PRODUCTO

Range designed for the floating suspension of sound-proofed walls. Sylomer® avoids the transmission of vibrations while providing optimal acoustic results.

They have a "FAIL SAFE" rugged metal structure, which is overload-proof.

Recommended for applications where fire or impact resistance is necessary.

These mounts are also suitable for the isolation of vertical pipes, or any type of light-weight ducts that need to be isolated.

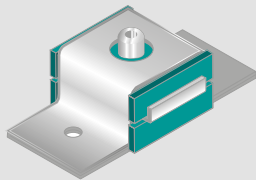
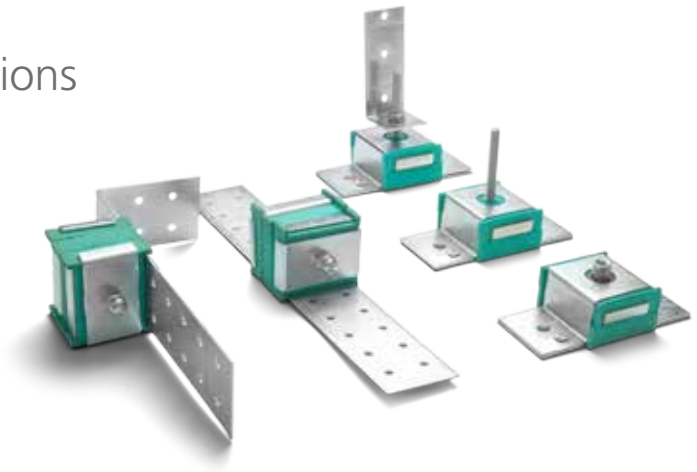

EP + Sylomer Type B

It is secured to the wall by means of two holes. It has a female M6 metal insert.

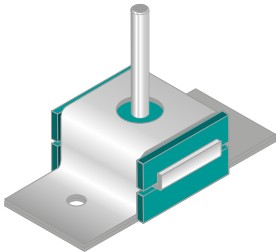
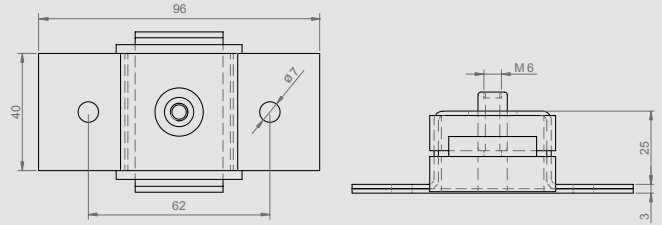

EP + Sylomer Type A

It is secured to the wall by means of two holes. It has a female M6 metal insert.

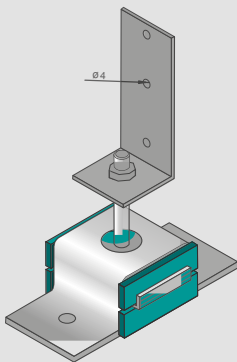
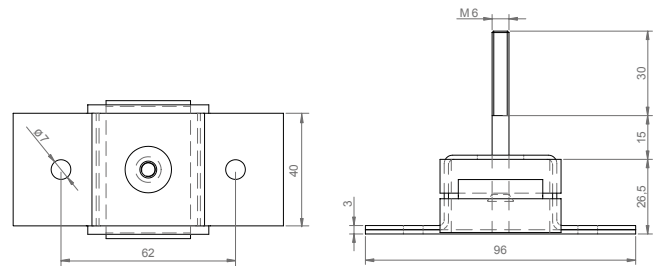

EP400 + Sylomer

It is secured to the wall by means of two holes. It has a male M6 metal insert and also an "L" welded nut for securing to the profile.

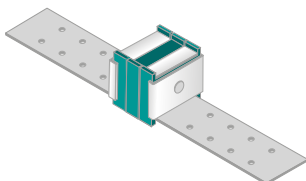
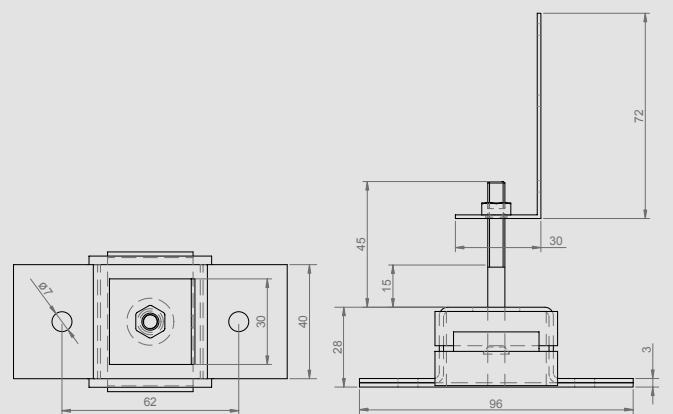

EP 600 + Sylomer

They are secured by two "predrilled" and easy-to-cut pins to facilitate their installation.

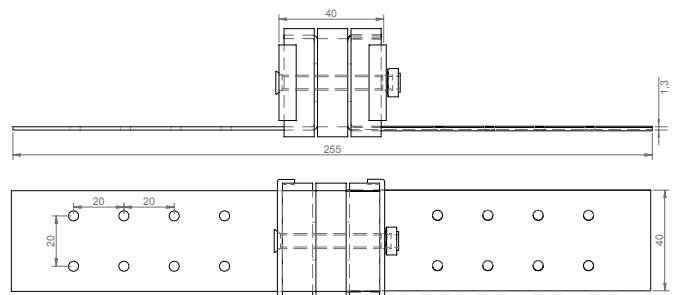

AKUSTIK + AMC Mecanocaucho & AKUSTIK+sylomer[®]

AKUSTIK + sylomer[®]

WALL MOUNTS

EP + Sylomer[®]: Models and dimensions

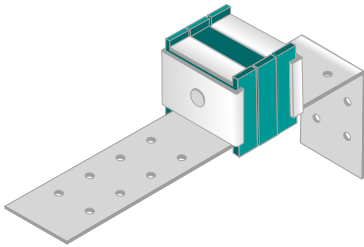

EP 650 + Sylomer

They are secured by two "predrilled" and bent pins to facilitate their installation.

This principle can be used to make a wide range of variants.

Contact us if you require a product more adapted to your building technique.

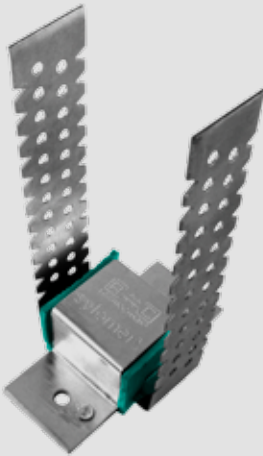
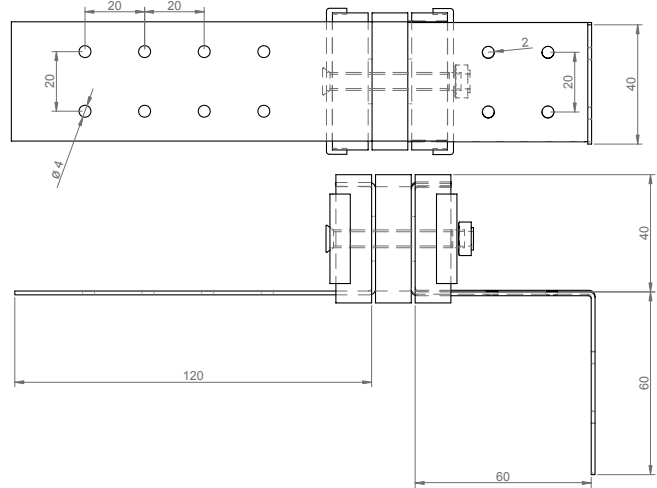

EP 700 + Sylomer

This wall mount has been designed to hold "C" profiles either in vertical or horizontal position.

Allows inclined ceilings with a simple and fast installation procedure.

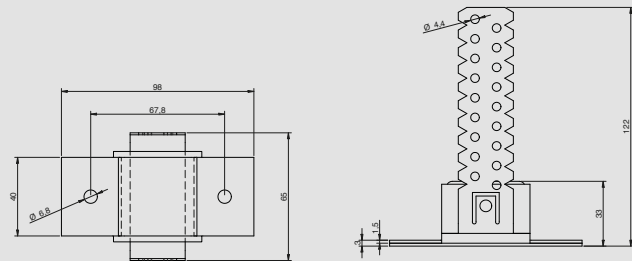

TECHNICAL CHARACTERISTICS

LOAD DEFLECTION GRAPH
 EP Akustik + Sylomer **25**

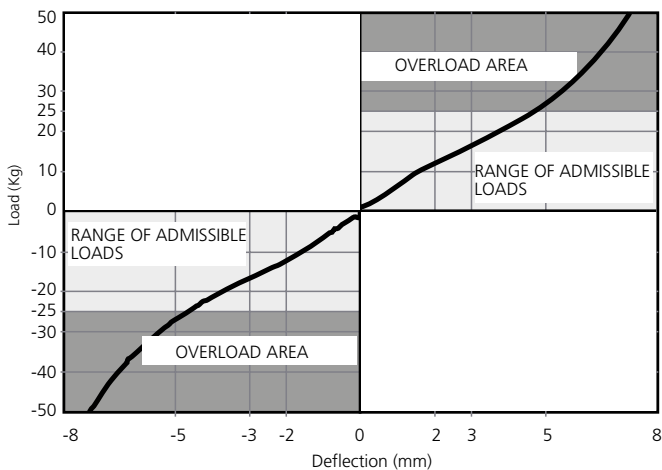

NATURAL FREQUENCY GRAPH
 EP Akustik + Sylomer **25**

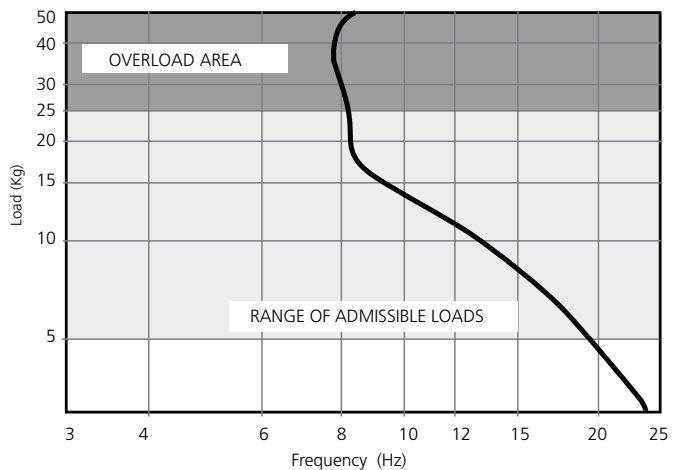

7pO
JD
3ODFH-DYD/RFDO
%URVVUG4F
-<

VXSSRUWSDVFDHFRP
ZZZSDVFDHFRP

AKUSTIK + AMC Mecanocaucho & AKUSTIK+**sylomer**[®]

AKUSTIK + **sylomer**[®] WALL MOUNTS

EP + Sylomer[®]: Applications



Euskalduna Auditorium Bilbao



Music School Helsinki