

CEILING MOUNTS

SRS + Sylomer®: Models and dimensions

PRODUCT DESCRIPTION

These antivibration mounts have been conceived for the suspension of suspended ceilings or machines that rotate at low frequency. The excellent properties of the Sylomer® microcellular polyurethane combined with the low stiffness of an steel spring achieve increased isolation values as opposed to other mounts using rubber or cork, or a combination of both.

These antivibration mounts are manufactured in 6 different steel spring models to adapt optimal for each application.

Their rugged metal parts withstand can tensile stresses. They are supplied with an anticorrosive treatment that can resist tensile stresses up to 1000Kg withstand the toughest environments.

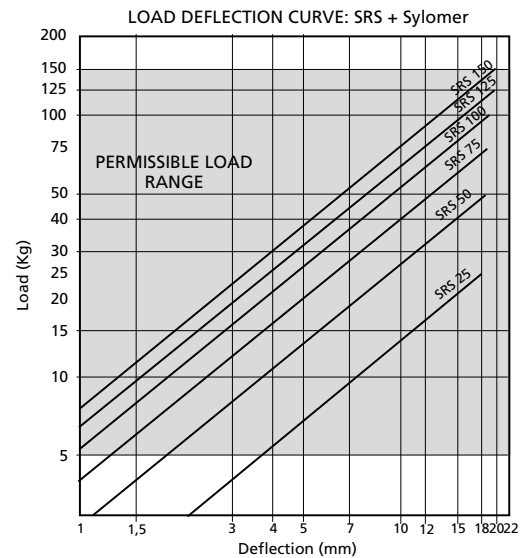
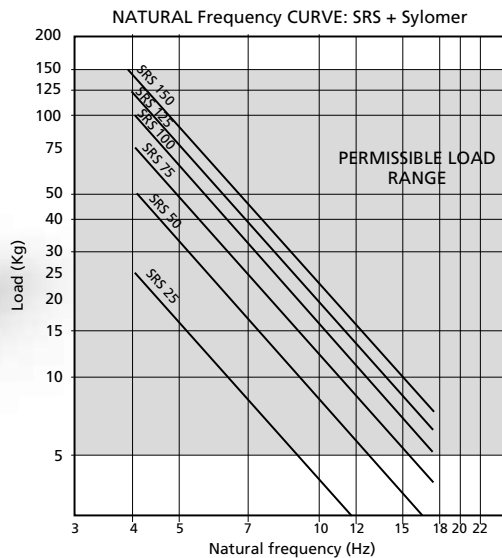
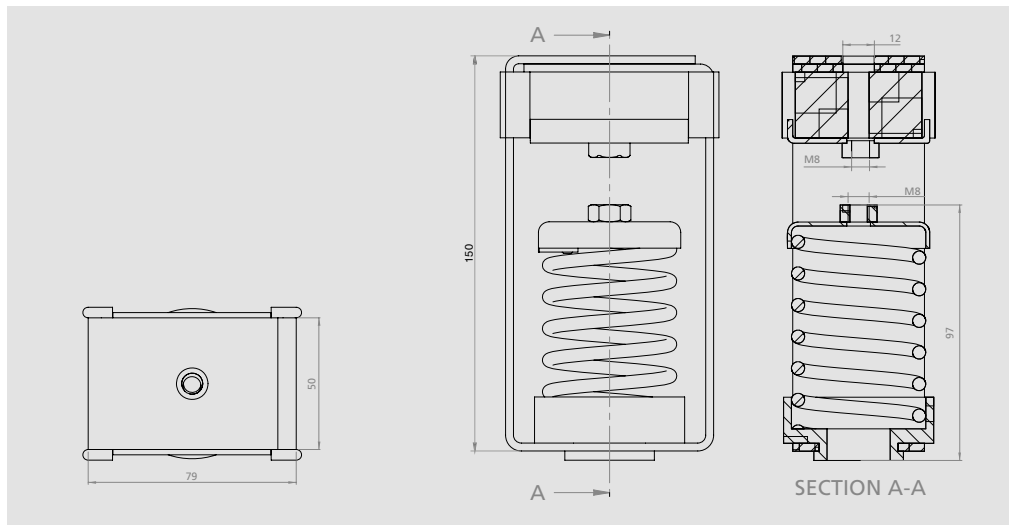
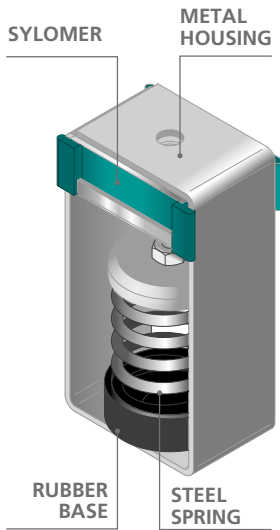





AKUSTIK + AMC Mecanocaucho & AKUSTIK+sylomer®

AKUSTIK + sylomer®

by getzner

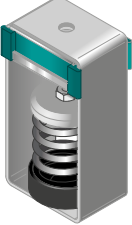
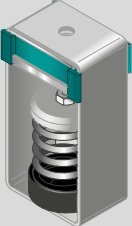
CEILING MOUNTS

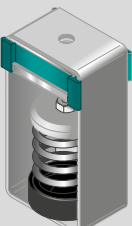
SRS + Sylomer®: Range

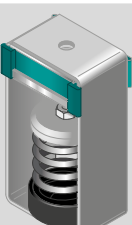
REF. AMC	SUMMARY	(Kg). MAX.LOAD	CODE
 <p>SRS 25 + Sylomer®</p>	Sylomer+Steel spring combined hanger.	25	23546
 <p>SRS 50 + Sylomer®</p>	Sylomer+Steel spring combined hanger.	50	23547
 <p>SRS 75 + Sylomer®</p>	Sylomer+Steel spring combined hanger.	75	23551
 <p>SRS 100 + Sylomer®</p>	Sylomer+Steel spring combined hanger.	100	23548
 <p>SRS 125 + Sylomer®</p>	Sylomer+Steel spring combined hanger.	125	23549
 <p>SRS 150 + Sylomer®</p>	Sylomer+Steel spring combined hanger.	150	23550